

SGT N-channel Power MOSFET

MTR3R5N08CT
TO-220CB

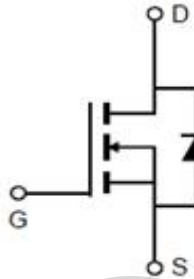
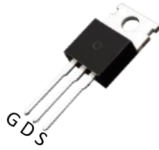

V_{DS}	80	V
$R_{DS(on),TYP}@ V_{GS}=10\text{ V}$	2.5	m Ω
I_D	160	A

Features

- 1、 Low on – resistance
- 2、 Package TO-220CB
- 3、 SGT N-channel Power MOSFET

Applications

- 1、 Motor control and drives
- 2、 DC/DC Converter

Maximum ratings, at $T_A = 25^\circ\text{C}$, unless otherwise specified

Symbol	Parameter	Rating	Unit	
$V_{(BR)DSS}$	Drain-Source breakdown voltage	80	V	
V_{GS}	Gate-Source voltage	± 20	V	
I_D	Continuous drain current @ $V_{GS}=10\text{V}$	$T_C = 25^\circ\text{C}$ (Silicon limit)	220	A
		$T_C = 25^\circ\text{C}$ (Package limit)	160	A
		$T_C = 100^\circ\text{C}$ (Silicon limit)	130	A
I_{DM}	Pulse drain current tested ①	$T_C = 25^\circ\text{C}$	640	A
E_{AS}	Avalanche energy, single pulsed ②		1296	mJ
P_D	Maximum power dissipation	$T_C = 25^\circ\text{C}$	227	W
T_{STG}, T_J	Storage and Junction Temperature Range		-55 to 150	$^\circ\text{C}$

Thermal Characteristics

Symbol	Parameter	Typical	Unit
R _{θJC}	Thermal Resistance, Junction-to-Case	0.53	°C/W
R _{θJA}	Thermal Resistance, Junction-to-Ambient	62	°C/W

Electrical Characteristics

Symbol	Parameter	Condition	Min.	Typ.	Max.	Unit
--------	-----------	-----------	------	------	------	------

Static Electrical Characteristics @ T_j=25°C (unless otherwise stated)

V(BR)DSS	Drain-Source Breakdown Voltage	V _{GS} =0V, I _D =250μA	80	--	--	V
I _{DSS}	Zero Gate Voltage Drain Current	V _{DS} =80V, V _{GS} =0V	--	--	1	μA
I _{GSS}	Gate-Body Leakage Current	V _{GS} =±20V, V _{DS} =0V	--	--	±100	nA
V _{GS(th)}	Gate Threshold Voltage	V _{DS} =V _{GS} , I _D =250μA	2.0	3.0	4.0	V
R _{DS(on)}	Drain-Source On-State Resistance ④	V _{GS} =10V, I _D =50A	--	2.5	3.5	mΩ
g _{fs}	Transconductance	V _{DS} =5V, I _D =40A	--	106	--	S

Dynamic Electrical Characteristics @ T_j = 25°C (unless otherwise stated)

C _{iss}	Input Capacitance	V _{DS} =40V, V _{GS} =0V, f=1MHz	--	7695	--	pF
C _{oss}	Output Capacitance		--	1122	--	pF
C _{rss}	Reverse Transfer Capacitance		--	202	--	pF
R _g	Gate Resistance	V _{GS} =0V, f=1MHz, V _{DS} =0V	--	1.7	--	Ω
Q _g (10V)	Total Gate Charge	V _{DS} =40V, I _D =50A, V _{GS} =10V	--	91	--	nC
Q _{gs}	Gate-Source Charge		--	37	--	nC
Q _{gd}	Gate-Drain Charge		--	25	--	nC

Switching Characteristics

Td(on)	Turn-on Delay Time	V _{DS} =40V, V _{GS} =10V, R _L =3.0Ω, T _J =25°C	--	38	--	ns
Tr	Turn-on Rise Time		--	58	--	ns
Td(off)	Turn-Off Delay Time		--	63	--	ns
Tf	Turn-Off Fall Time		--	32	--	ns

Source- Drain Diode Characteristics@ T_J = 25°C (unless otherwise stated)

VSD	Forward on voltage	I _{SD} =50A, V _{GS} =0V	--	0.85	1.2	V
Trr	Reverse Recovery Time	I _F =30A, di/dt=500A/μs	--	85	--	ns
Qrr	Reverse Recovery Charge	I _F =30A, di/dt=500A/μs	--	226	--	nC

- NOTE: ① Repetitive rating; pulse width limited by max junction temperature.
 ② Limited by T_{Jmax}, starting T_J = 25°C, L = 0.5mH, R_g = 25Ω. Part not recommended for use above this value.
 ③ The power dissipation P_{DSM} is based on R_{θJA} and the maximum allowed junction temperature of 150°C.
 ④ Pulse width ≤ 380μs; duty cycle ≤ 2%.

Typical Characteristics

Fig 1: Output Characteristics

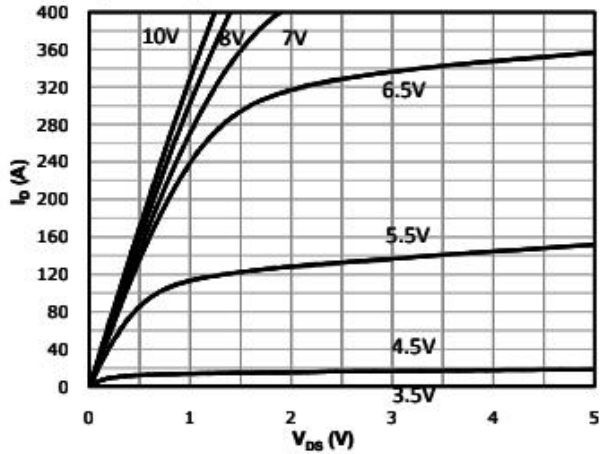
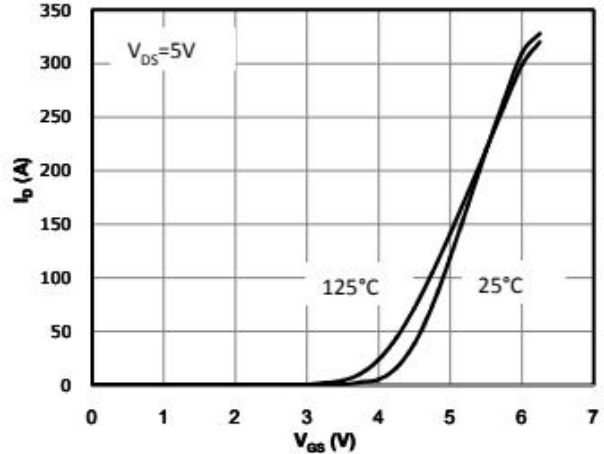

Fig 2: Transfer Characteristics



3: $R_{ds(on)}$ vs Drain Current and Gate Voltage

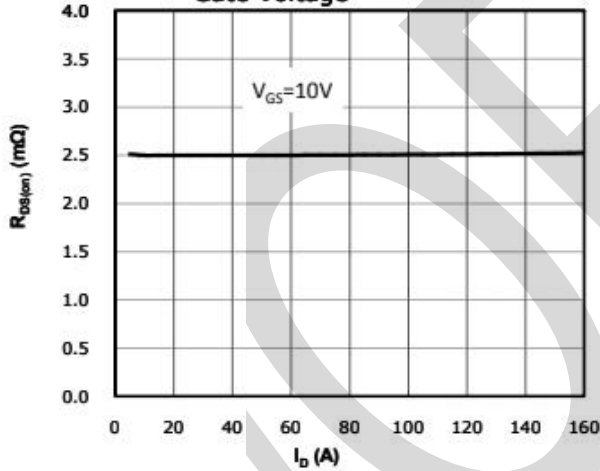

Fig 4: $R_{ds(on)}$ vs Gate Voltage

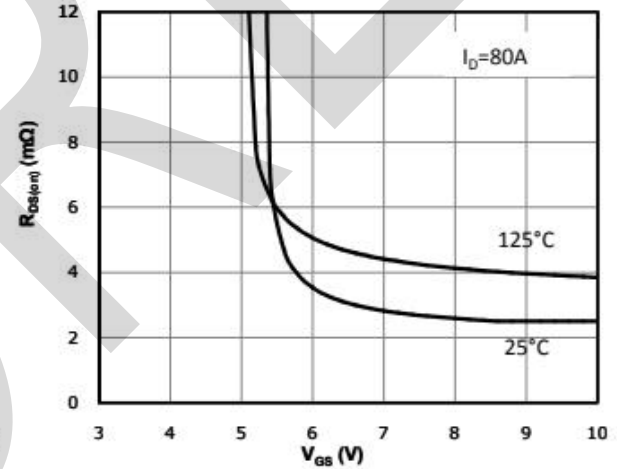

Fig 5: $R_{ds(on)}$ vs. Temperature

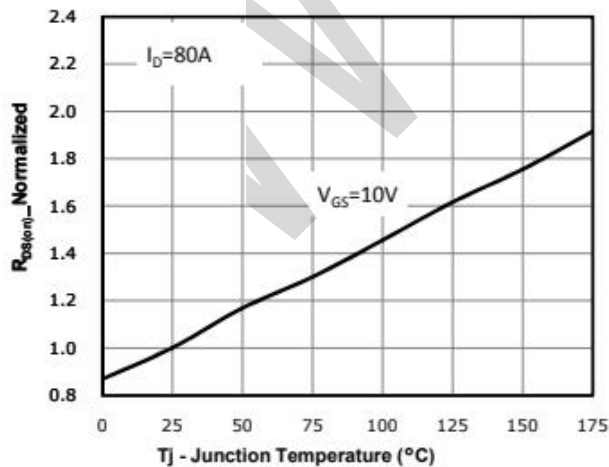
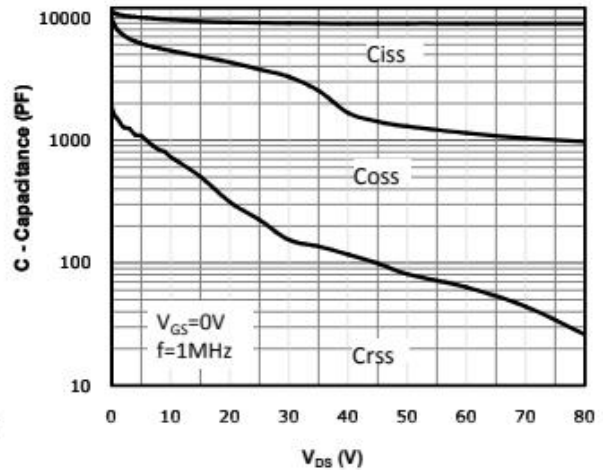

Fig 6: Capacitance Characteristics



Typical Characteristics

Fig 7: Gate Charge Characteristics

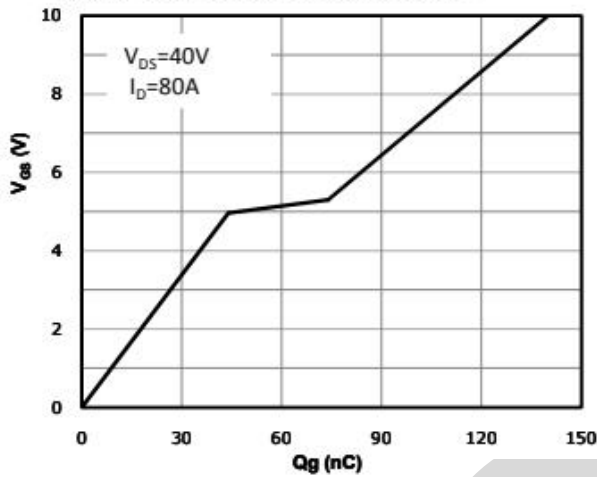

Fig 8: Body-diode Forward Characteristics

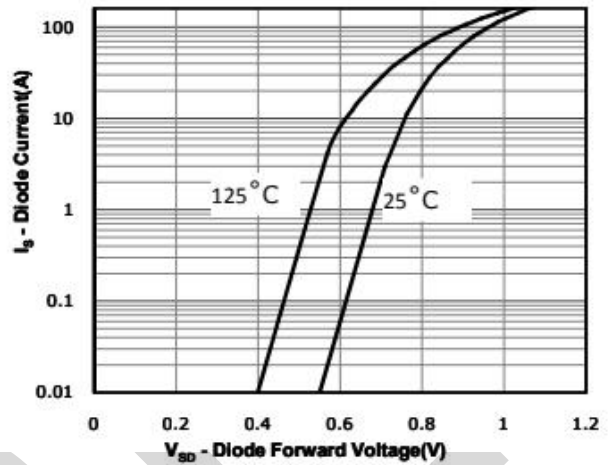

Fig 9: Power Dissipation

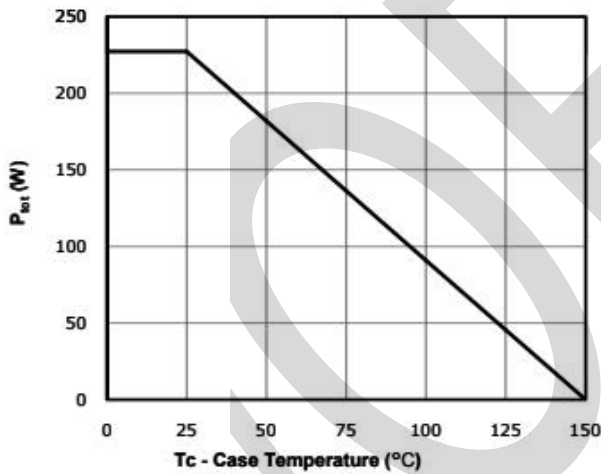

Fig 10: Drain Current Derating

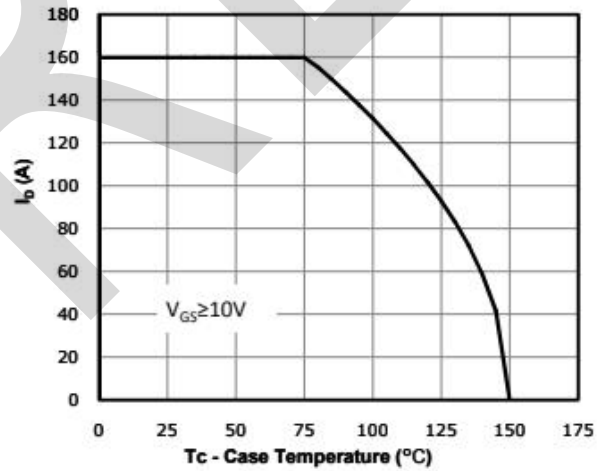
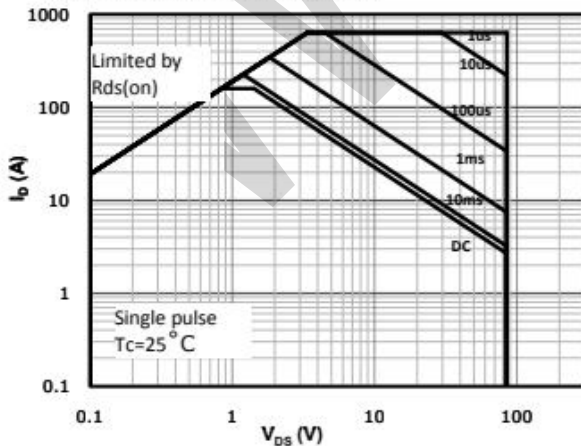
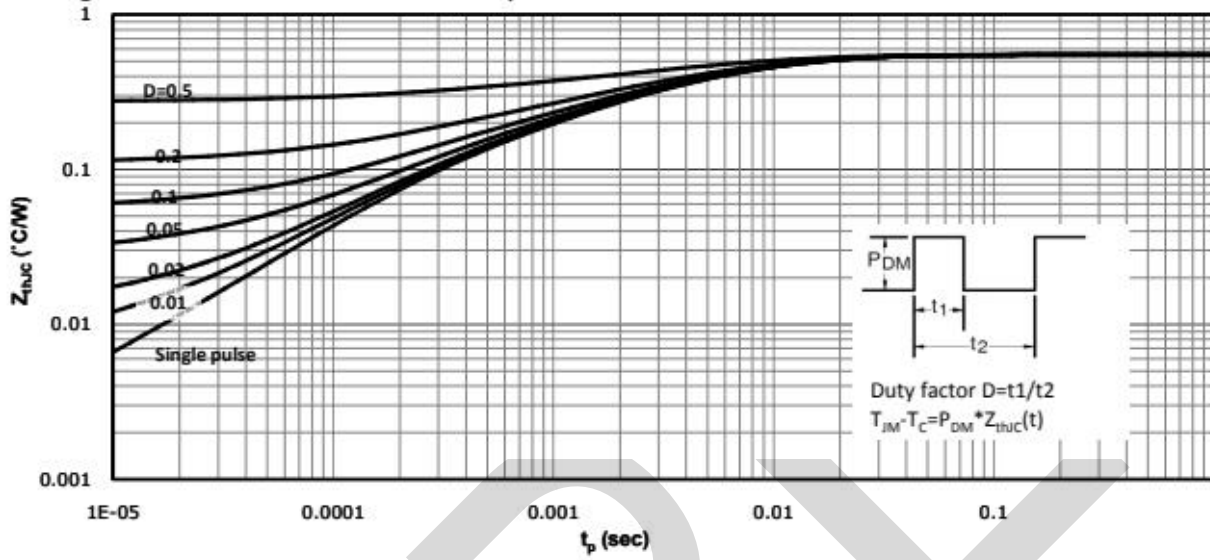

Fig 11: Safe Operating Area



Typical Characteristics

Fig 12: Max. Transient Thermal Impedance



PACKAGE OUTLINE DIMENSIONS

TO-220CB

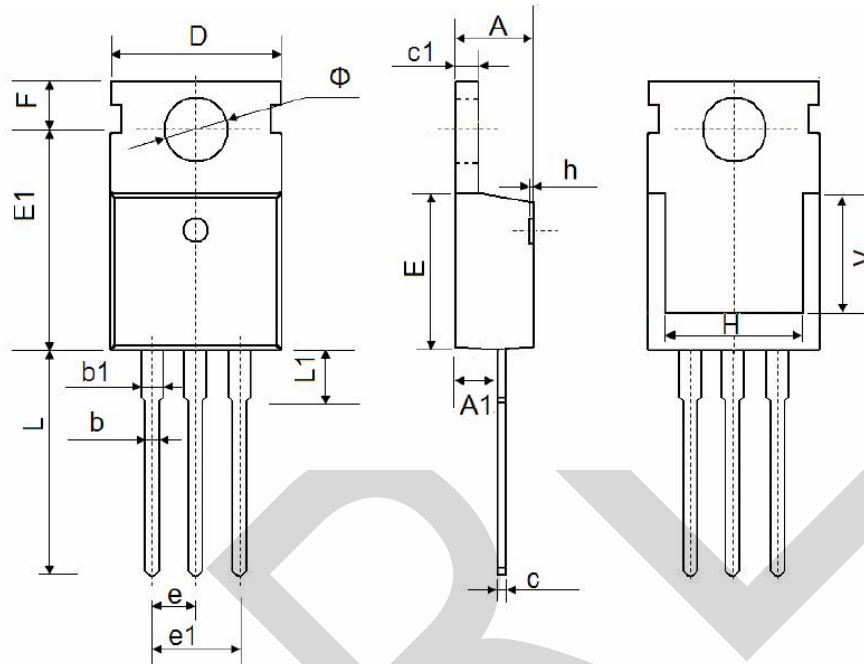

Symbol	Dimensions In Millimeters		Dimensions In Inches	
	Min.	Max.	Min.	Max.
A	4.400	4.600	0.173	0.181
A1	2.250	2.550	0.089	0.100
b	0.710	0.910	0.028	0.036
b1	1.170	1.370	0.046	0.054
c	0.330	0.650	0.013	0.026
c1	1.200	1.400	0.047	0.055
D	9.910	10.250	0.390	0.404
E	8.950	9.750	0.352	0.384
E1	12.650	12.950	0.498	0.510
e	2.540 Typ.		0.100 Typ.	
e1	4.980	5.180	0.196	0.204
F	2.650	2.950	0.104	0.116
H	7.900	8.100	0.311	0.319
h	0.000	0.300	0.000	0.012
L	12.900	13.400	0.508	0.528
L1	2.850	3.250	0.112	0.128
V	7.500 Ref.		0.295 Ref.	
Φ	3.400	3.800	0.134	0.150