

SGT N-channel Power MOSFET

MTR4R6N10SD PDFN5x6

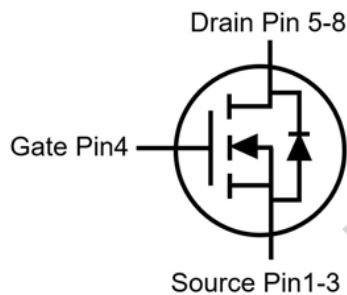
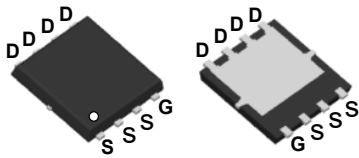

V_{DS}	100	V
$R_{DS(on),TYP@ V_{GS}=10V}$	4.5	m Ω
I_D	120	A

Features

- 1、 Low on – resistance
- 2、 High power package (PDFN5X6)
- 3、 SGT N-channel Power MOSFET
- 4、 Halogen free

Applications

- 1、 Load Switch for Portable Devices
- 2、 DC/DC Converter

Maximum ratings, at $T_A = 25^\circ\text{C}$, unless otherwise specified

Symbol	Parameter	Rating	Unit
$V_{(BR)DSS}$	Drain-Source breakdown voltage	100	V
V_{GS}	Gate-Source voltage	± 20	V
I_S	Continuous Source Current	$T_C = 25^\circ\text{C}$ 120	A
I_D	Continuous drain current @ $V_{GS}=10V$	$T_C = 25^\circ\text{C}$ 120	A
		$T_C = 100^\circ\text{C}$ 76	A
I_{DM}	Pulse drain current tested ①	$T_C = 25^\circ\text{C}$ 480	A
E_{AS}	Avalanche energy, single pulsed ②	320	mJ
P_D	Maximum power dissipation	$T_C = 25^\circ\text{C}$ 131.6	W
T_{STG}, T_J	Storage and Junction Temperature Range	-55 to 150	$^\circ\text{C}$

Thermal Characteristics

Symbol	Parameter	Rating	Unit
R _{θJC}	Thermal Resistance, Junction-to-Case	0.95	°C/W
R _{θJA}	Thermal Resistance, Junction-to-Ambient	48	°C/W

Electrical Characteristics

Symbol	Parameter	Condition	Min.	Typ.	Max.	Unit
--------	-----------	-----------	------	------	------	------

Static Electrical Characteristics @T_j=25°C (unless otherwise stated)

V(BR)DSS	Drain-Source Breakdown Voltage	V _{GS} =0V, I _D =250μA	100	--	--	V
I _{DSS}	Zero Gate Voltage Drain Current	V _{DS} =100V, V _{GS} =0V	--	--	1	μA
I _{GSS}	Gate-Body Leakage Current	V _{GS} =±20V, V _{DS} =0V	--	--	±100	nA
V _{GS(th)}	Gate Threshold Voltage	V _{DS} =V _{GS} , I _D =250μA	1.2	1.8	2.5	V
R _{DS(on)}	Drain-Source On-State Resistance ④	V _{GS} =10V, I _D =20A	--	3.6	4.5	mΩ
		V _{GS} =4.5V, I _D =15A	--	5.2	6.7	mΩ

Dynamic Electrical Characteristics @T_j = 25°C (unless otherwise stated)

C _{iss}	Input Capacitance	V _{DS} =50V, V _{GS} =0V, f=1MHz	--	5475	--	pF
C _{oss}	Output Capacitance		--	768	--	pF
C _{rss}	Reverse Transfer Capacitance		--	22	--	pF
g _{fs}	Forward Transconductance	V _{DS} = 10V, I _D = 20A	70	--	--	S
R _g	Gate Resistance	f = 1MHz	--	1.3	--	Ω
Q _g	Total Gate Charge	V _{DS} =50V, I _D =20A, V _{GS} =10V	--	111.2	--	nC
Q _{gs}	Gate-Source Charge		--	17.5	--	nC
Q _{gd}	Gate-Drain Charge		--	30.2	--	nC

Switching Characteristics

Td(on)	Turn-on Delay Time	V _{DD} =10V, V _{GS} =10V I _D =40A, R _G =1Ω	--	33.3	--	ns
Tr	Turn-on Rise Time		--	33.3	--	ns
Td(off)	Turn-Off Delay Time		--	95.2	--	ns
Tf	Turn-Off Fall Time		--	35.6	--	ns

Source- Drain Diode Characteristics@ T_j = 25°C (unless otherwise stated)

VSD	Forward on voltage	I _S =20A, V _{GS} =0V	--	--	1.2	V
Trr	Reverse Recovery Time	I _F =20A	--	59.4	--	ns
Qrr	Reverse Recovery Charge	di/dt=100A/μs	--	91.8	--	nC

- NOTE: ① Repetitive rating; pulse width limited by max junction temperature.
 ② Limited by T_{Jmax}, starting T_J = 25°C, V_{DD}=25V, V_{GS}=10V, L=0.4mH, I_{AS}=40A. Part not recommended for use above this value
 ③ The power dissipation P_{DSM} is based on R_{θJA} and the maximum allowed junction temperature of 150°C.
 ④ Pulse width ≤ 300μs; duty cycle ≤ 2%.

Typical Characteristics

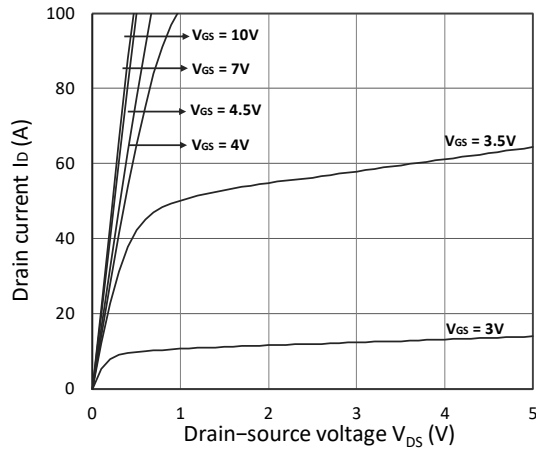

Figure 1. Output Characteristics

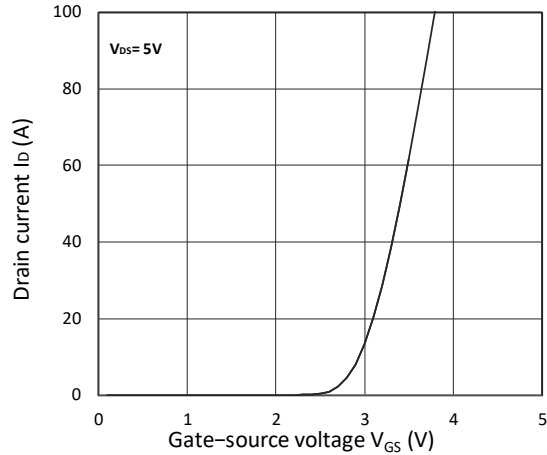

Figure 2. Transfer Characteristics

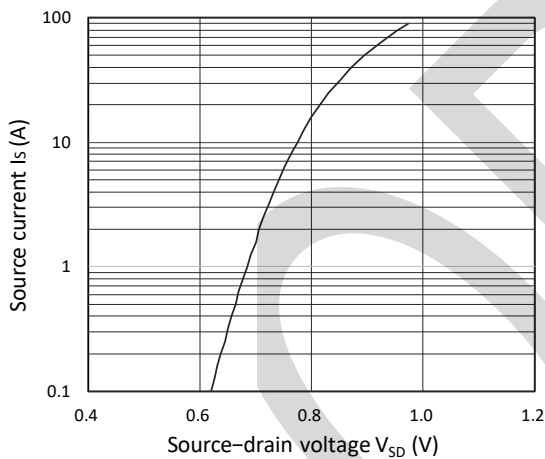

Figure 3. Forward Characteristics of Reverse

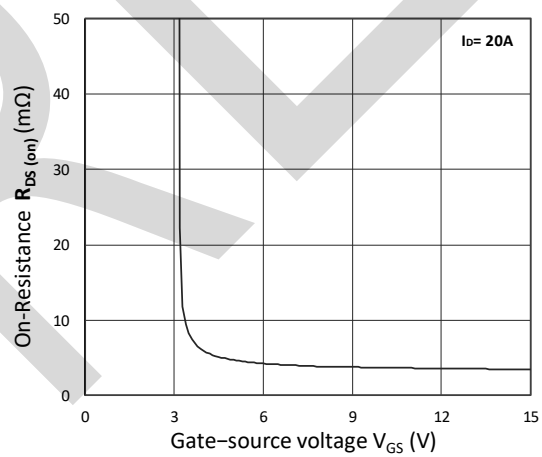

Figure 4. $R_{DS(ON)}$ vs. V_{GS}

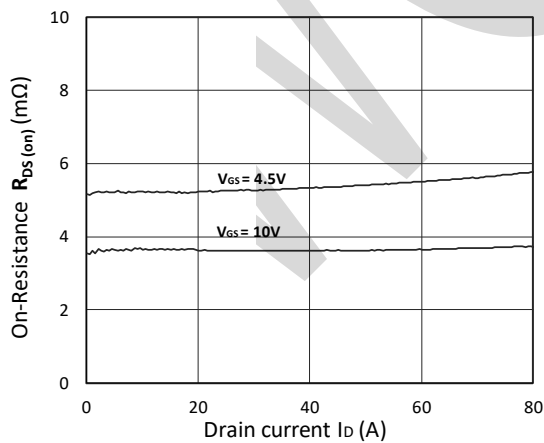

Figure 5. $R_{DS(ON)}$ vs. I_D

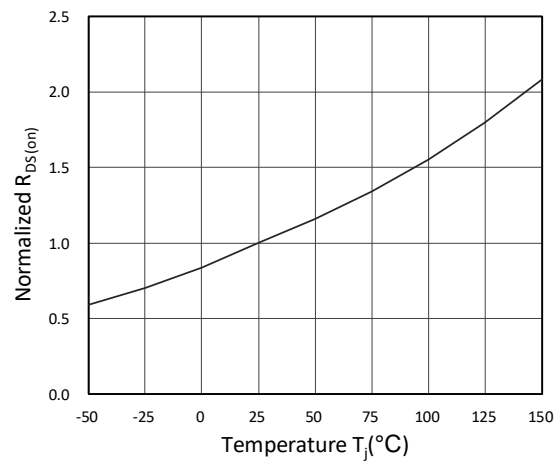

Figure 6. Normalized $R_{DS(ON)}$ vs. Temperature

Typical Characteristics

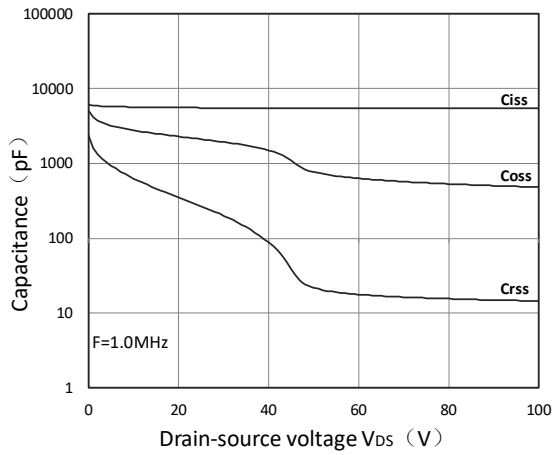

Figure 7. Capacitance Characteristics

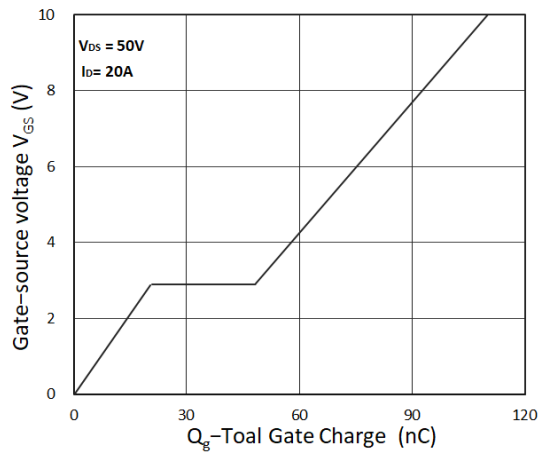

Figure 8. Gate Charge Characteristics

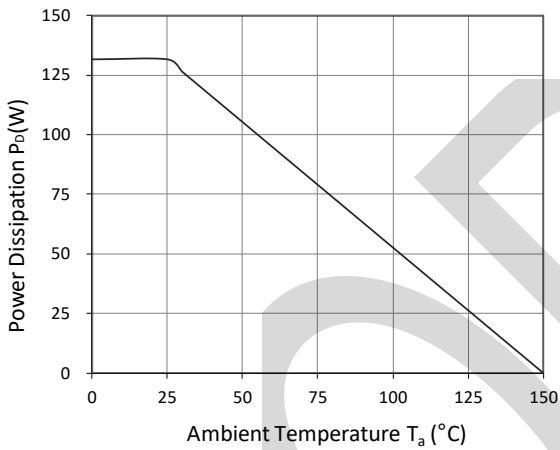

Figure 9. Power Dissipation

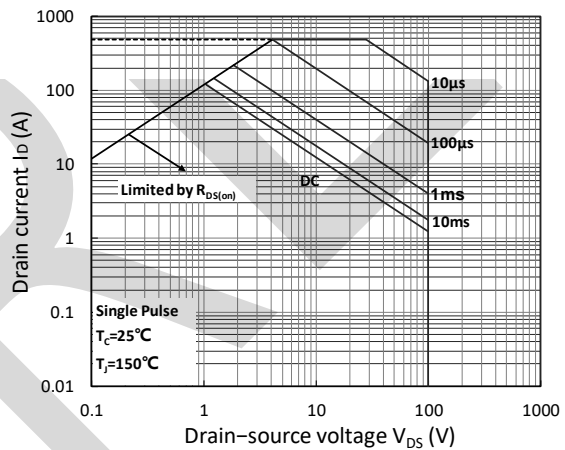

Figure 10. Safe Operating Area

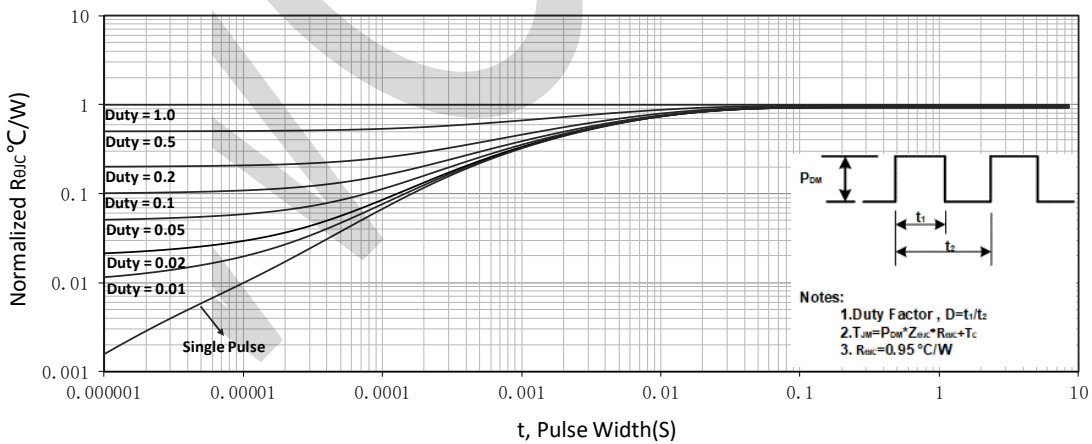
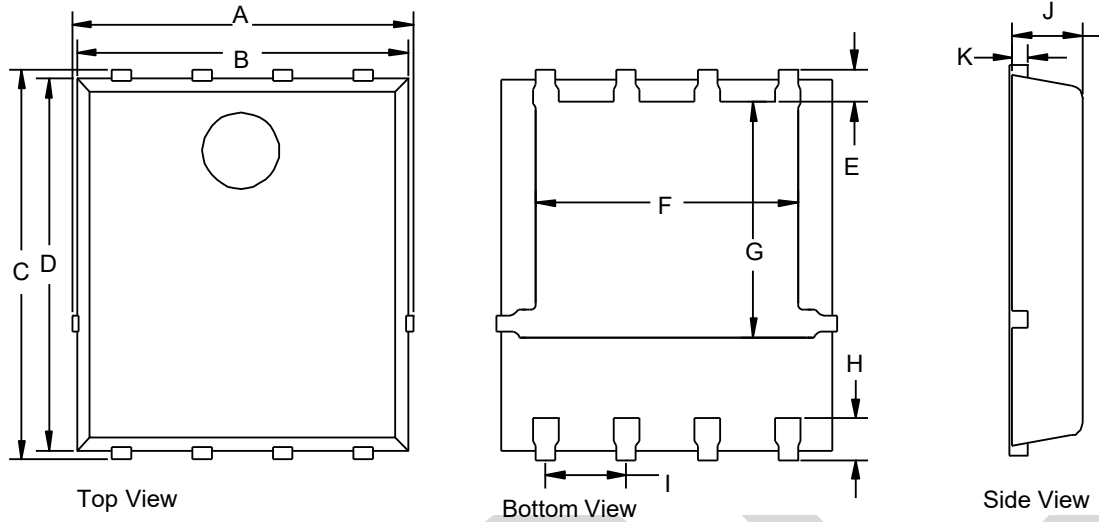

Figure 11. Normalized Maximum Transient Thermal Impedance

PACKAGE OUTLINE DIMENSIONS



PDFN5x6 mechanical data

UNIT		A	B	C	D	E	F	G	H	I	J	K
mm	min	4.90	4.8	5.90	5.66	0.60	3.90	3.30	0.53	1.27	0.9	0.254
	max	5.55	5.4	6.35	6.06		4.32	3.92	0.76		1.2	
mil	min	192.9	188.9	232.3	222.8	23.6	153.5	129.9	20.8	50.0	35.4	10.0
	max	218.5	212.6	250.0	238.6		170.1	154.3	29.9		47.2	

PDFN5x6 Suggested Pad Layout

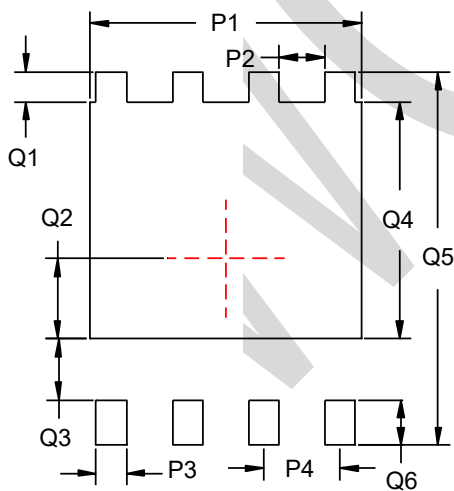

UNIT		P1	P2	P3	P4	Q1
mm	min	4.52	0.76	0.51	1.27	0.50
mil	min	177.9	29.9	20.07	50.0	20.0

UNIT		Q2	Q3	Q4	Q5	Q6
mm	min	1.34	1.02	3.97	6.25	0.76
mil	min	52.75	40.15	156.30	246.06	29.92